

The Design, Marketing and Production of Maynard Rifles

Max W. Goodwin

While Edward Maynard's career as a dentist and his business as a firearms manufacturer may seem quite disparate, I am going to try to demonstrate that the two were inseparably intertwined. I will tell you about Dr. Edward Maynard, his inventions, his career as a dentist, his inventive bent, and how he may have used contacts made as a result of his amazing dental skills and worldwide reputation as a dentist, to help in the marketing of his guns.

Edward Maynard was born April 26, 1813 to Moses and Chloe Butler Maynard in Madison, New York. His father, a farmer, was also sheriff of Madison County and served as a Major in the New York State Militia during the War of 1812. Moses instilled in young Edward, an interest in the military. Edward was appointed to West Point by his father's friend, DeWitt Clinton, one time Governor of New York and United States Senator, who was a major force behind the creation of the Erie Barge Canal.

Maynard's health did not allow him to withstand the rigors of military life at West Point and he resigned during his

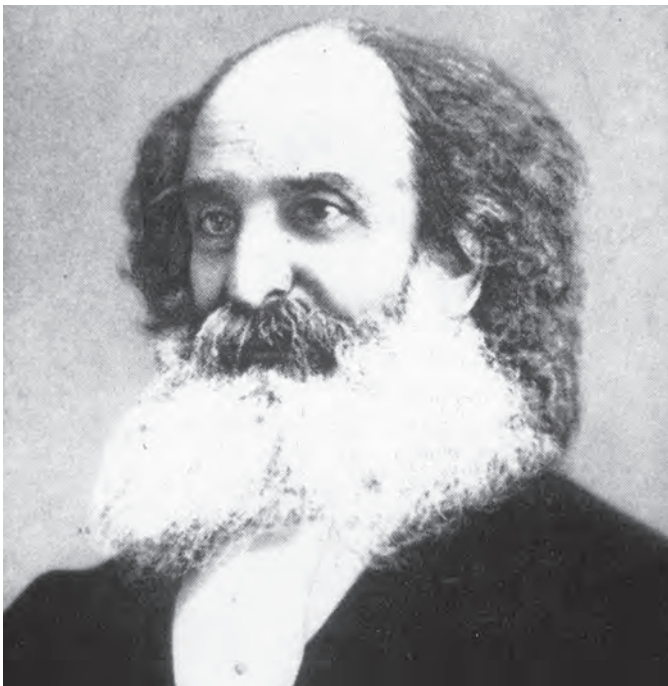

Figure 1. Edward Maynard photo, date and photographer unknown.



first year. Sometime after leaving West Point, he served a brief apprenticeship in dentistry, and established a practice in Washington, DC, in about 1836. He proved to be a brilliant dentist and dental researcher, and helped "bring dentistry from the deplorable depths of quackery, to a science dedicated to the betterment of mankind."¹ In eight short years, he moved to a major position of eminence in the field of dentistry. He discovered ways of doing surgery which minimized the pain for the patient, and he was "nearly hypnotic in his ability to calm his patient's fears and relax them in the chair."¹

His remarkable skill and ability justified his fees which were high, and for this and other reasons discussed later, he became quite wealthy. He bought a fine mansion located at 2425 L St., Washington, DC. The mansion, built in 1812, was originally known as the Ringgold House, later the Maynard Mansion, and finally became the Columbia Women's Hospital.

Maynard was also an excellent artist and was awarded an honorary Master of Arts Degree by Columbia College. His son, George W. Maynard, who became a successful artist, made this drawing of his father. Dr. Maynard designed the insignia adopted by the American Society of Dental Surgeons, which was also adopted by the British Journal of Dentistry.

Maynard's interests were many and varied. I had a patent search done in 1983 that resulted in 31 patents; as



Figure 2. The Maynard Mansion, 2425 I Street, Washington, D.C. (Photo taken from the now defunct Columbia Women's Hospital, courtesy of Washington Historical Society.)

you would expect, most of them were firearms related. I know the search was deficient in omitting at least one firearms patent, the first and arguably most important, his tape priming system. This search uncovered no dental patents, and probably was deficient in this regard as well. The transcript of *Edward Maynard Prince of Dentists* states he was developing dental tools and equipment long before he started patenting gun inventions, and that he was known among his peers as "the blacksmith dentist" because he spent so much time working on special surgical instruments. He held a number of patents not relating to either guns or dentistry. The non-gun/related patents are as follows:



A REPRODUCTION OF MAYNARD'S SEAL OF THE AMERICAN SOCIETY OF DENTAL SURGEONS

Figure 4. Seal of American Society of Dental Surgeons, designed by E. Maynard.

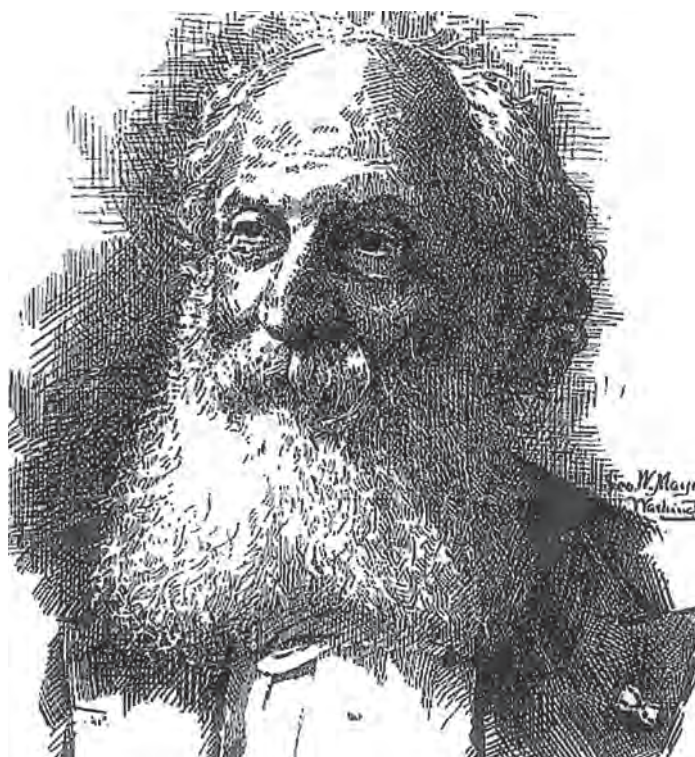

Figure 3. Edward Maynard as drawn by George W. Maynard, his son.

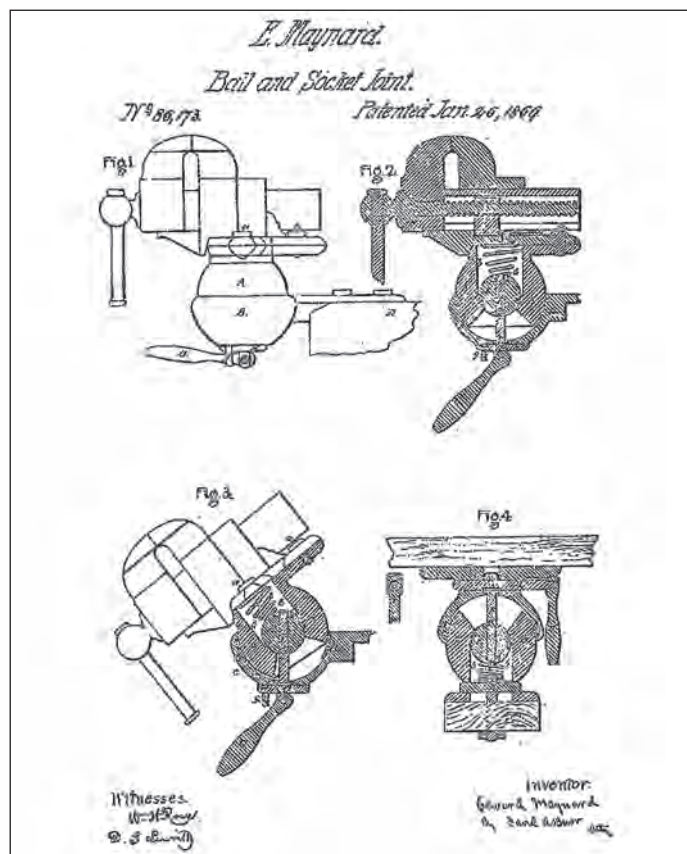

Figure 5. Ball and Socket Joint.

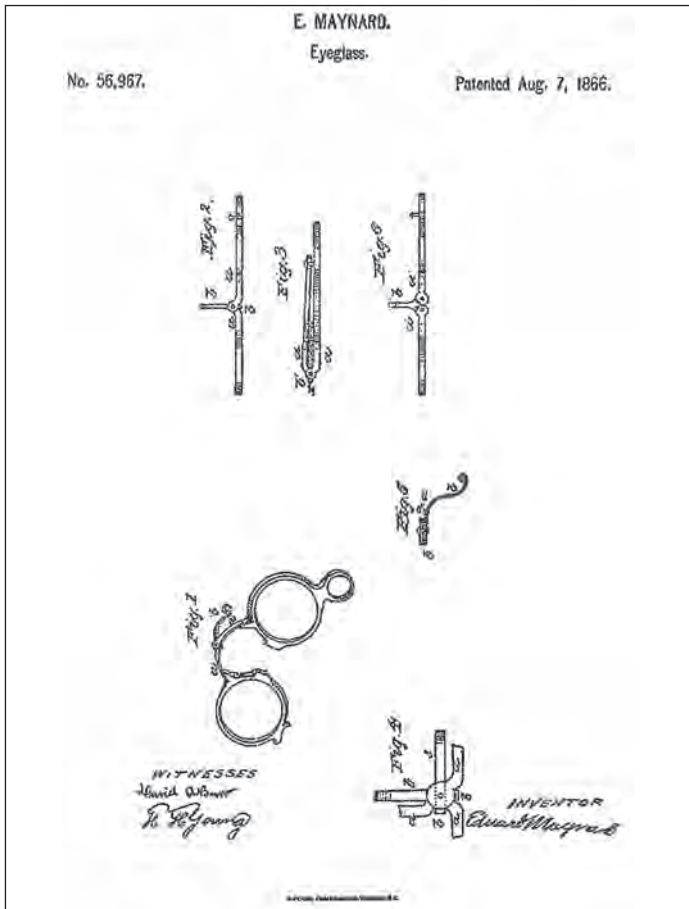

Figure 6. Folding Eyeglasses.

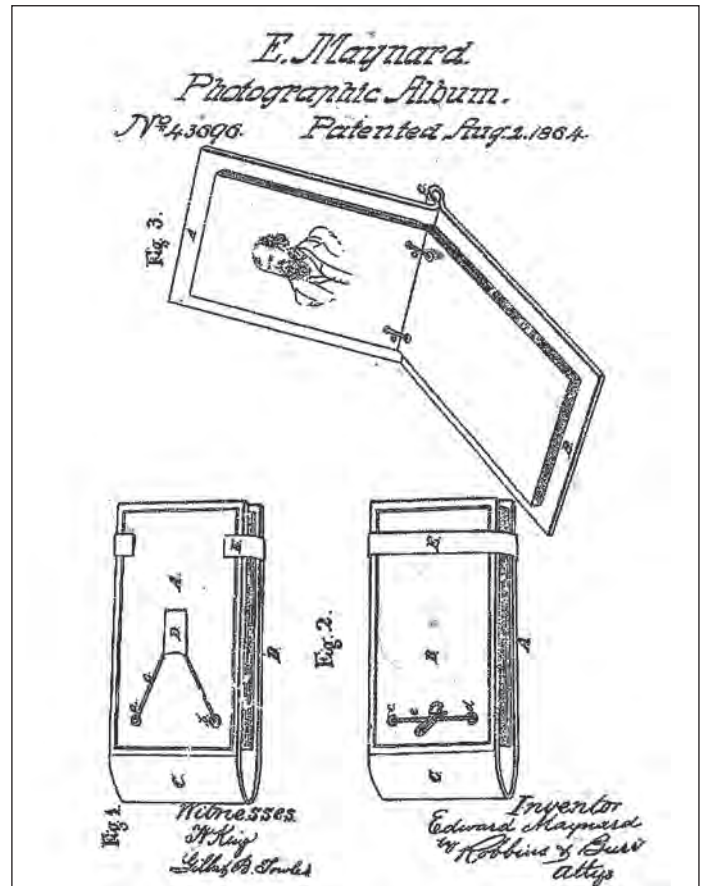

Figure 8. Photographic Album.

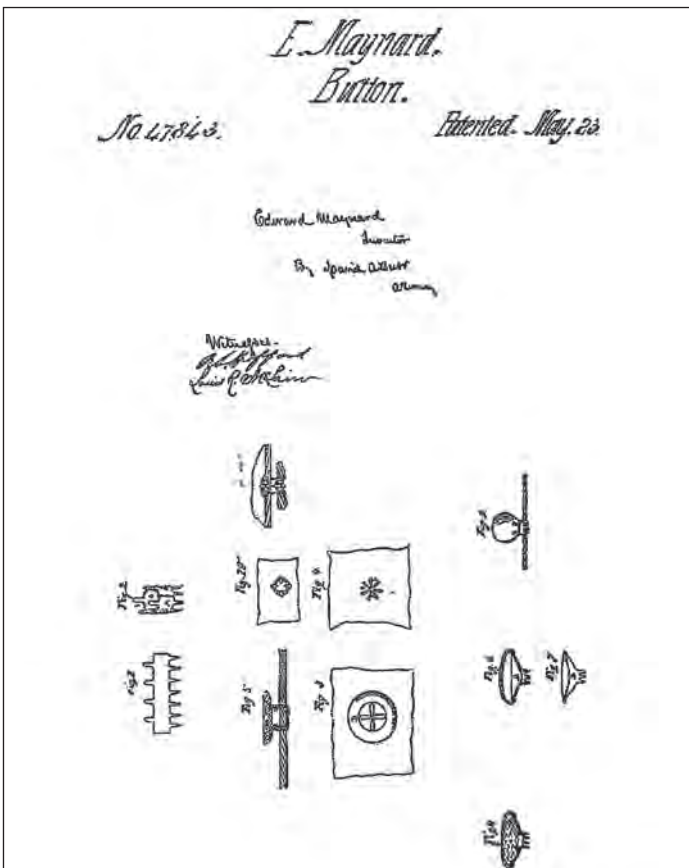

Figure 7. Button.

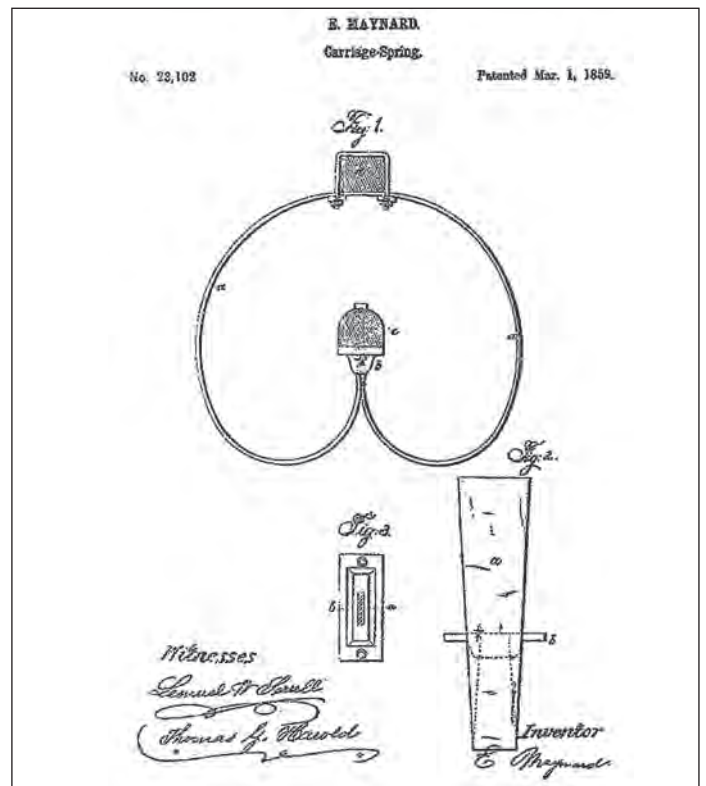

Figure 9. Buggy Spring (one of two he patented).

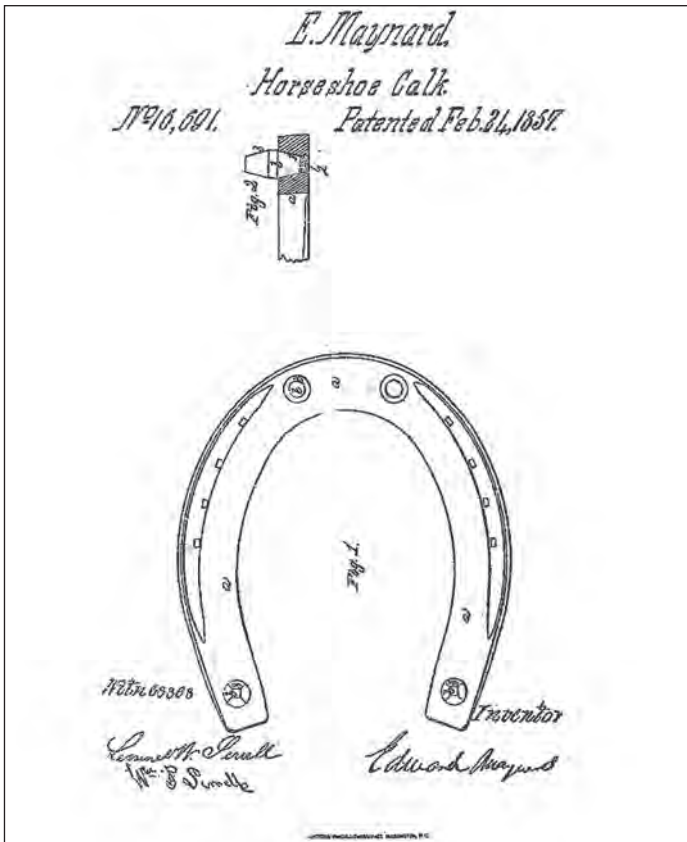

Figure 10. Horseshoe Calk.

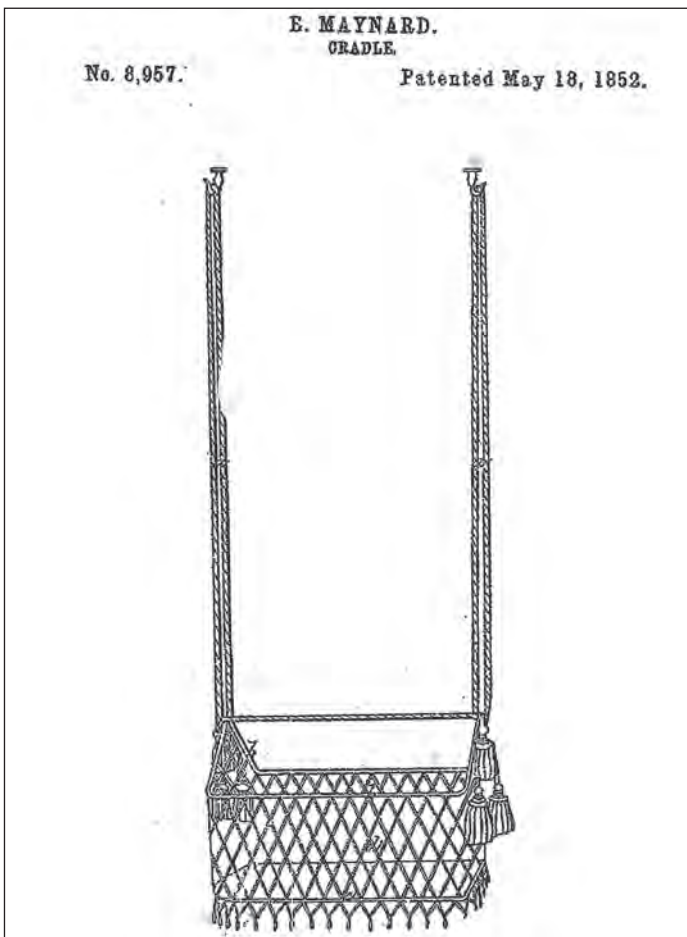

Figure 11. Cradle.

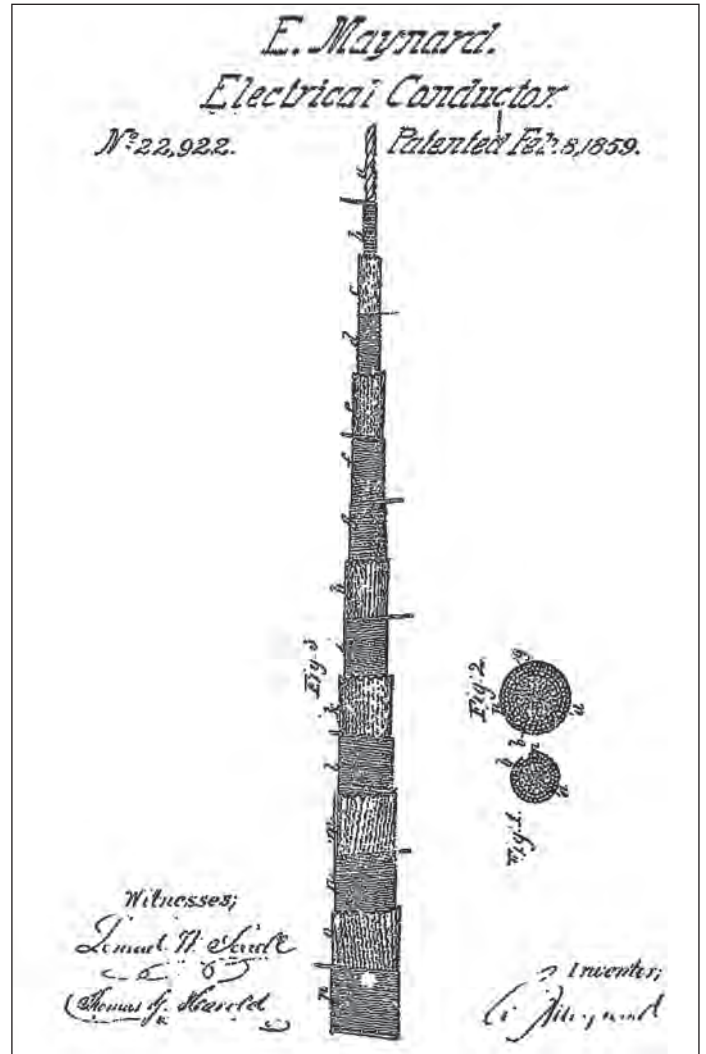

Figure 12. Undersea Electrical Conductor.

I am not going to try to list all his accomplishments in dentistry, but I do want to enumerate some of the honors he was accorded both in dentistry and firearms, because I believe those honors, and more importantly, the influential friends and clients he developed, were a major factor in getting his firearms to the market, and particularly the American military market.

Here is a partial list of those honors:

Honorary Doctor of Dental Surgery, Baltimore College, 1842.

Honorary Master of Arts, Columbia College, Washington, DC, date unknown.

Honorary Doctor of Medicine, Western Medical College, 1840.

Honorary Fellow, American Academy of Dental Science, 1867.

Member, International Medical Congress (date unknown).

Member, European Society of American Dentists (date unknown).

Appointed Actual Dentist to His Imperial Majesty and the Imperial Family, by Tsar Nichols I. The Tsar paid his fee, and gave Dr. Maynard a ring set with sixty diamonds surrounding an enormous carbuncle. (A carbuncle is a polished rounded garnet crystal).

Received the Medal of Merit from the King of Sweden.

Made Chevalier of the Military Order of the Red Eagle, by King of Prussia.²

Received the personal Complements of the King of Belgium.

Designated "Prince of Dentists" by Virginia State Dental Association, 1878.

These honors show the wide esteem in which Maynard was held by his peers and clients, domestic and foreign. But for purposes of marketing his guns, I believe that his reputation as a dentist (and no doubt the publicity that must have gone with it) attracted notable members of Washington society, *including top politicians*, to his dental office. Many of them became both clients and friends. It is well documented that he was a close friend of Jefferson Davis, President Franklin Pierce, and President Abraham Lincoln. There are several known cased sets of guns and accoutrements which were presented to prominent politicians and Generals. Were these tokens of friendship or were they an inducement for the government to buy guns? Probably both! In a letter dated May 18, 1860, Wm. P. McFarland says "I am very sorry to hear that your back is giving you trouble this year. I hope you will recover from all your aches and pains and be able to fight the good fight and *come off 'conqueror' and win the congress*" (emphasis added). Apparently, association with congressmen and other politicians was as important then as it is now.

Maynard preserved a valuable resource for us in our efforts to learn about his guns, in the form of the letters which he received from William P. McFarland, both while McFarland was an employee of Maynard Arms, and later as an employee of Massachusetts Arms Company, making guns for Maynard. These letters are preserved partly in the National Archives and partly in personal collections of individuals. Unfortunately, I know of the existence of none of Maynard's letters to McFarland.

William Putnam McFarland was instrumental in the design, production, testing and marketing of Maynard rifles. The only source of personal information about him that I have found is his obituary. He was born in 1818 in Sturbridge, Mass. He began to learn the machinist's trade at Harvey Waters of Millbury, Ct., manufacturer of cotton and woolen machinery, for which he was paid \$5 per month and board. Subsequently, he went to Stafford, CT to work for Elijah Fairman on cotton machinery. He then worked for his brothers in Leicester, making card setting machin-

ery, followed in Worcester at Court Mills, again making cotton machinery. In 1843 he became an employee of the Springfield Armory, where for the next thirteen years he worked in various positions, becoming expert in the manufacture of firearms. He moved to Chicopee Falls, Mass in 1857 to work for the Maynard Arms Company of Washington, DC. According to his obituary, he was interested in the Lamb Machine Co., for a number of years, but the nature of that interest is unknown. At the time of his death, he was Vice President of the Chicopee Falls Savings Bank, and president of the Belcher & Taylor Agricultural Tool Company.

It is difficult to be certain about many aspects of one-sided correspondence, but some things become clear. It has been generally believed that all Maynard guns were manufactured by Massachusetts Arms Company. But the McFarland letters make it clear that the Maynard Arms Company owned manufacturing equipment and did some amount of arms building, independent of Massachusetts Arms Co.

Here are some excerpts from letters from McFarland to Maynard:

Worcester, Mass, January 19, 1857.

"I do not know as you are aware that I am not connected with the U. S. Armory in Springfield any, at present at least (sic). I left there last April and am now in Worcester engaged in the manufacture of card setting machines with a brother of mine." The letter is very critical of the management of the armory, and continues: "I have been thinking that I should like to get a good chance in the employ of the government at inspecting or some other business which I am competent to do. *It is for your aid to secure such a position that I now write you*" (emphasis added).

This is the earliest indication from McFarland that he believed Maynard to be influential with representatives of the Federal Government.

The next letter available is again from Worcester, Mass, and is dated May 1, 1857. It clearly indicates that McFarland was working for Maynard.

"As I am very busy at work on the model, I do not get much time to do much towards making an estimate for your armory in Washington. I have, however, estimated numbers of machines it will require for making barrels, 3,000 per year, and the probable cost for good machines. They are as follows, viz:"

He then continues by listing drilling machines, boring spindle banks, turning engines, lathes, etc., with a total estimate of \$3,475.

This is a good point to give you a better feel about the dollars involved. Sometime in the 1850s, Maynard sold his tape priming patent to the federal government for a final total \$75,000. I was curious about what that might be worth

Consumer Price Index (CPI) Conversion Factors 1800 to estimated 2013 to Convert to Dollars of 2003 (estimated)

To convert dollars of any year to dollars of the year 2003 (estimated), DIVIDE the dollar amount from that year by the conversion factor (CF) for that year.
For example, \$1000 dollars of 1925 = \$10,528 dollars of 2003 (\$1000 / 0.095)

Dollar series since 1912 have changed periodically, so numbers are not all precisely comparable. Therefore, it is recommended that numbers be rounded to no more than three decimal places. For example, \$10,528 in the example above becomes \$10,500. For years prior to 1913, using two decimal places is recommended, e.g. \$10,528 becomes \$11,000 (two decimals).

Note: To reverse the process, that is, to determine what a 2003-dollar amount would be in dollars of another year, simply multiply the year 2003 amount by the conversion factor for that year. For example, \$1000 dollars of (estimated) 2003 would be \$76 in 1840 (\$1000 x 0.076 = \$76), again rounded to 3 or 2 decimal places.

Year	CF	Year	CF	Year	CF	Year	CF	Year	CF	Year	CF
1800	0.071	1840	0.049	1880	0.038	1920	0.100	1960	0.161	2000	0.806
1801	0.072	1841	0.049	1881	0.038	1921	0.099	1961	0.162	2001	0.802
1802	0.061	1842	0.049	1882	0.038	1922	0.099	1962	0.164	2002	0.808
1803	0.064	1843	0.042	1883	0.038	1923	0.099	1963	0.160	2003	1.000
1804	0.067	1844	0.042	1884	0.038	1924	0.098	1964	0.159	2004	1.002
1805	0.066	1845	0.043	1885	0.038	1925	0.098	1965	0.171	2005	1.040
1806	0.069	1846	0.041	1886	0.034	1926	0.096	1966	0.170	2006	1.038
1807	0.065	1847	0.047	1887	0.034	1927	0.096	1967	0.192	2007	1.034
1808	0.071	1848	0.045	1888	0.034	1928	0.095	1968	0.189	2008	1.120
1809	0.070	1849	0.044	1889	0.032	1929	0.093	1969	0.200	2009	1.148
1810	0.070	1850	0.044	1890	0.031	1930	0.091	1970	0.211	2010	1.177
1811	0.074	1851	0.044	1891	0.031	1931	0.085	1971	0.220	2011	1.207
1812	0.079	1852	0.044	1892	0.031	1932	0.074	1972	0.227	2012	1.207
1813	0.089	1853	0.044	1893	0.031	1933	0.071	1973	0.241	2013	1.330
1814	0.100	1854	0.048	1894	0.034	1934	0.073	1974	0.268		
1815	0.097	1855	0.049	1895	0.048	1935	0.074	1975	0.263		
1816	0.079	1856	0.049	1896	0.048	1936	0.076	1976	0.300		
1817	0.078	1857	0.049	1897	0.048	1937	0.079	1977	0.300		
1818	0.072	1858	0.049	1898	0.047	1938	0.077	1978	0.295		
1819	0.072	1859	0.047	1899	0.047	1939	0.076	1979	0.305		
1820	0.066	1860	0.047	1900	0.048	1940	0.076	1980	0.448		
1821	0.064	1861	0.050	1901	0.048	1941	0.060	1981	0.454		
1822	0.066	1862	0.057	1902	0.048	1942	0.059	1982	0.520		
1823	0.069	1863	0.074	1903	0.050	1943	0.064	1983	0.542		
1824	0.065	1864	0.060	1904	0.051	1944	0.066	1984	0.565		
1825	0.068	1865	0.062	1905	0.050	1945	0.069	1985	0.585		
1826	0.068	1866	0.060	1906	0.051	1946	0.104	1986	0.590		
1827	0.067	1867	0.061	1907	0.050	1947	0.121	1987	0.894		
1828	0.064	1868	0.060	1908	0.052	1948	0.131	1988	0.883		
1829	0.063	1869	0.077	1909	0.051	1949	0.128	1989	0.874		
1830	0.062	1870	0.074	1910	0.054	1950	0.131	1990	0.711		
1831	0.049	1871	0.069	1911	0.054	1951	0.141	1991	0.741		
1832	0.049	1872	0.069	1912	0.054	1952	0.144	1992	0.743		
1833	0.048	1873	0.068	1913	0.054	1953	0.145	1993	0.746		
1834	0.048	1874	0.065	1914	0.054	1954	0.148	1994	0.808		
1835	0.050	1875	0.062	1915	0.055	1955	0.148	1995	0.829		
1836	0.053	1876	0.061	1916	0.059	1956	0.148	1996	0.853		
1837	0.051	1877	0.060	1917	0.071	1957	0.152	1997	0.873		
1838	0.053	1878	0.057	1918	0.062	1958	0.157	1998	0.856		
1839	0.053	1879	0.057	1919	0.061	1959	0.156	1999	0.907		

data.

Conversion factors for years prior to 1913 are based from data in John A. McOyster, "How Much Is That in Real Money?" Proceedings of the American Antiquarian Society (2001), Table A-1, Column B.
(Note: These conversion factors are calculated from McOyster's data, not supplied in his original source.)
CPI is CPI-U, the broader measure for all urban consumers, year-to-year average (not December to December).

format is
2013_2013
format is
2003-2003

CF in Excel format starting 1866 are available at http://www.orst.edu/Dept/pol_cdf/foia/cpi/1865503.xls
CF in pdf (Adobe Acrobat) format starting 1865 are available at http://www.orst.edu/Dept/pol_cdf/foia/cpi/1865503.pdf

4/29/03
Rev 5/16/2005

(c) 2003 Robert C. Sahr, Political Science Department, Oregon State University, Corvallis, OR 97331-4200
e-mail: robert.sahr@osu.edu WWW: http://www.orst.edu/Dept/pol_cdf/foia/cpi/foia/cpi.html

Figure 13. Consumer Price Index conversion chart, year 1800 to current.

in purchasing power in today's dollars, and toward that end, utilized this chart prepared by Robert C. Sahr. It is a chart of estimated conversion factors to restate prices to 2002 dollars for each year since 1800. Since the print is quite small, I excerpted the relevant years in larger form, which I hope you can read. Though these are estimates of a group of economists, they are based on the best information available and give us a reasonable basis for comparison. To use this chart, locate the appropriate year, and divide the number of dollars by the conversion factor given. In this example, divide \$75,000 by the factor .047 (year 1858). The \$75,000 payment, based on this chart, would equate to almost \$1.6 million. Obviously, defense contracting paid well.

To return to McFarland's cost estimate in his May 1857 letter, the \$3,475 estimate for machinery would equate to about \$74,000, and his further estimated cost of \$3,000 for a 30 horsepower engine, when converted, amounts to about \$64,000. So in today's dollars, he was talking about almost a \$140,000 initial investment just for machinery to start an armory. There is no evidence that all of this equipment was purchased, but at least a lathe and its tooling were.

Confirmation of McFarland's employment by Maynard Arms Company was found in records housed in the National

Year	CF
1840	0.049
1841	0.049
1842	0.046
1843	0.042
1844	0.042
1845	0.043
1846	0.044
1847	0.047
1848	0.045
1849	0.044
1850	0.044
1851	0.044
1852	0.044
1853	0.044
1854	0.048
1855	0.049
1856	0.048
1857	0.049
1858	0.047
1859	0.047
1860	0.047
1861	0.050
1862	0.057
1863	0.071
1864	0.089
1865	0.092
1866	0.090
1867	0.084
1868	0.080
1869	0.077

Figure 14. Excerpt from CPI chart for years 1840 to 1869.

Museum of American History. A copy of the minutes of that company's first board meeting is dated May 2, 1857. William W. Corcoran was elected President, William G. Freeman Secretary, and George W. Riggs Treasurer. William P. McFarland was appointed "Inspector and Model Maker" to be paid an annual salary of \$1,500. Reporting to the President, he was "to make all models and be held responsible that all arms fabricated for the company are of the best materials and workmanship, and conform in all respects to the patterns furnished and to the requirements of the Contract". . . . The minutes do not tell anything about "the Contract" but that will be clarified later.

By May 5, 1857, the date of the next letter, McFarland had moved to Chicopee Falls. In this letter, McFarland wrote:

"I suppose you do not wish me to spend any time making estimates for an armory when I can be at work upon the model. I therefore spend my evenings, what time I can spare, for that purpose. It will however, before making anything like an accurate estimate, be necessary to spend some time away from my work. I have found no one to help me as yet. I do not expect to until I start out and look up someone." . . . "I can keep someone at work with me to advantage." . . . "It is difficult to find workmen who are competent to do model work, who are not already engaged somewhere." . . . "I wish to

increase the size of the muzzle of the barrel .02 of an inch from the old one.”

These quotes imply to me that he was not working in the Mass Arms Factory, but rather may have been working at his home or some unknown location.

McFarland continued in this and subsequent letters, to describe in detail the development of the Maynard rifle, and the competitive testing of a variety of makes and models by the military. On July 16, 1858, *still before any contract with Massachusetts Arms*, McFarland was at West Point testing the carbine and writes:

“your gun (has) done very much better shooting at 600 yards than either Sharps’ or Burnside’s, which are the only ones which have been tried at that distance.” . . . “We fired 20 shots each at 600 yards. Sharps gun missed the target 4 times and shot all over the target and Burnside’s did much worse than that. I fired my 20 shots and only 2 missed the target and those were just over the top nearly central with the target. I fired all a little too high.”

An example of McFarland’s contribution to the design of the rifle is included in his letter dated May 19, 1857 he talks extensively of the design of sights and the stock for the carbine and includes a sketch of the gun’s under lever (McFarland’s design). The design was adopted by Maynard.

It is apparent that somewhere along the way, a firm decision was made by Maynard Arms Company, not to build an armory. In a document dated August 15th, 1857, the Maynard Arms Company and the Massachusetts Arms Company agree that Massachusetts Arms Company will manufacture “five thousand breech loading rifle Carbines,” like a model to be furnished by Wm. P. McFarland, said models to be stamped “W.P.McF” on the frame, in the bottom of the trap box, and on the barrel. The contract is signed by W. W. Corcoran and T. W. Carter³, each for their respective companies.

In a letter dated September 10th, 1858, McFarland stated:

“The new sample gun with small caliber is nearly complete. I think it the most perfect piece of work I have yet made & would like to get a case made for it.”

In subsequent letters, there are many references to development of styles and calibers, but still no clarification about the place of manufacture.

The first mention of a double barreled gun was in August, 1860, in which McFarland writes:

“Mr. Ventriss of Mississippi” . . . “would like a double barreled gun” . . . “So would Mr. Tyler and many others.”

(More on double guns further on.)

This letter also contains the only critical reference to Massachusetts Arms Co. He writes:

“I am now destitute of primers. Can you get some from the government in some way? The Massachusetts Arms

Co., are so slack about making them that we shall be obliged to make different arrangements to get a supply, I am fearful.”

His letter of January 6, 1861 tells that Maynard was thinking of relocating his firearms business to Washington, DC. McFarland wrote:

“I received your letter of December 31, yesterday afternoon, but not in season to telegraph to you. I can only say that I could go to Washington if wanted by the company. What the old tools can be bought of Mr. Carter for, I cannot tell, but probably for about what the company would offer for them, as they would be of no use to the Massachusetts Arms Co., unless they manufacture more of the guns”. If you continue to manufacture rifles after the present model, many of the tools would work in to a very great advantage.” . . . “If you make a new model, it would of course require new tools.”

He also mentions sending 600 guns to Syrus and Bro., and preparing 1000 small calibers with rings and sights for Florida, and also 300 without rings and sights for Mississippi, and 500 50 caliber with 20 and 26 inch barrels, also for Mississippi.

McFarland’s next few letters discuss various business matters and his views of the “rebels”, and his regret that they could use Maynard rifles to use to try to destroy the union. However, on October 3, 1861, it is clear that the Maynard Arms Company was being shut down:

“I have just been to the post office and received a letter to close up, as I expected, from Mr. Bestor⁴ with orders to suspend operations on the alteration of arms. I have got one of the pistols well underway, but shall stop work on it immediately.” . . . “What does the company propose to do with their lathe tools? I have no doubt that Mr. Carter would be very glad to buy the *lathe and all of the tools that belong to it*” . . . “I do not know where I shall be located. It is possible I shall not have this place. Yet I may. Wherever I do go, I shall try to have the Maynard rifle manufactured upon some terms if possible.”

Ten days later, on October 13, 1861, McFarland stated that he would be engaged with the Massachusetts Arms Co., to commence at the 1st of November, 1861.

Clearly, most Maynard rifles and accoutrements were made and marked by Massachusetts Arms Co. But the whereabouts of the models made by McFarland remains a mystery. And where are the test rifles used by the military? As I said, these rifles were made and tested before the contract with Massachusetts Arms was executed. A few bullet molds are marked only “Maynard Arms Co. Washington, D.C.” Could some rifles be marked similarly?

I mentioned the reference to double guns in August 1860. Were any of these made, and if so how were they marked? Ron Peterson has an unmarked Maynard type double rifle on his table, which might be one of the early rifles since it does not incorporate the features of Maynard’s

patent dated August 20, 1868. The primary claim of this patent is that the barrels can move independently as they get warm from firing, so that the aiming point does not change for either barrel. The next three exhibits show a double barreled shotgun, which is at the National Firearms Museum at NRA headquarters. The shotgun was made by Massachusetts Arms Company, and has "Maynard's Patent" and the date on the outside of the primer box cover, but does not appear to be a Maynard gun.

Dr. Maynard asked about the conversion of his own double gun, which does incorporate the features of Maynard's double gun patent dated October 20, 1858. These next exhibits show details of the application of Maynard's 1868 patent to his own double rifle. In a letter dated September 9, 1873, McFarland told Maynard

"I think there will be no difficulty in altering your double gun to use our new cartridge. We have finished a few 4/10 & 35/100 & shall have 64/100 completed in a few days. In regard to rifling a 64 shot bbl, I think they are too light & we

have no rifling rod for that size and it would interfere too much with our rifle business at this time to fit up for it. We have a mould for round ball for the 55 caliber shot which would make a good bear killer."

The conversion of Maynard's double would have been to the new Maynard 1873 cartridge, and as you can see from the exhibits, the space between the barrel and the action is proper for that cartridge, so apparently it was converted.

Nearly the last letter from McFarland, indicates that Maynard was trying to set up an organization to make double rifles. McFarland says he is too old and in no condition to take the supervision of it, "but will give such advice in the matter as I can to any company who shall undertake it, if desirable".

Were double guns, other than Maynard's personal one, made using the Maynard Patent? Copies of Maynard's patents are on my table, so you can look at the drawing and description. If any other Maynard doubles incorporating his patent are known, I would very much like to hear about them.



Figure 15. Double Barreled Shotgun by Massachusetts Arms Co.



Figure 16. Lock Plate of Mass. Arms Double Shotgun.

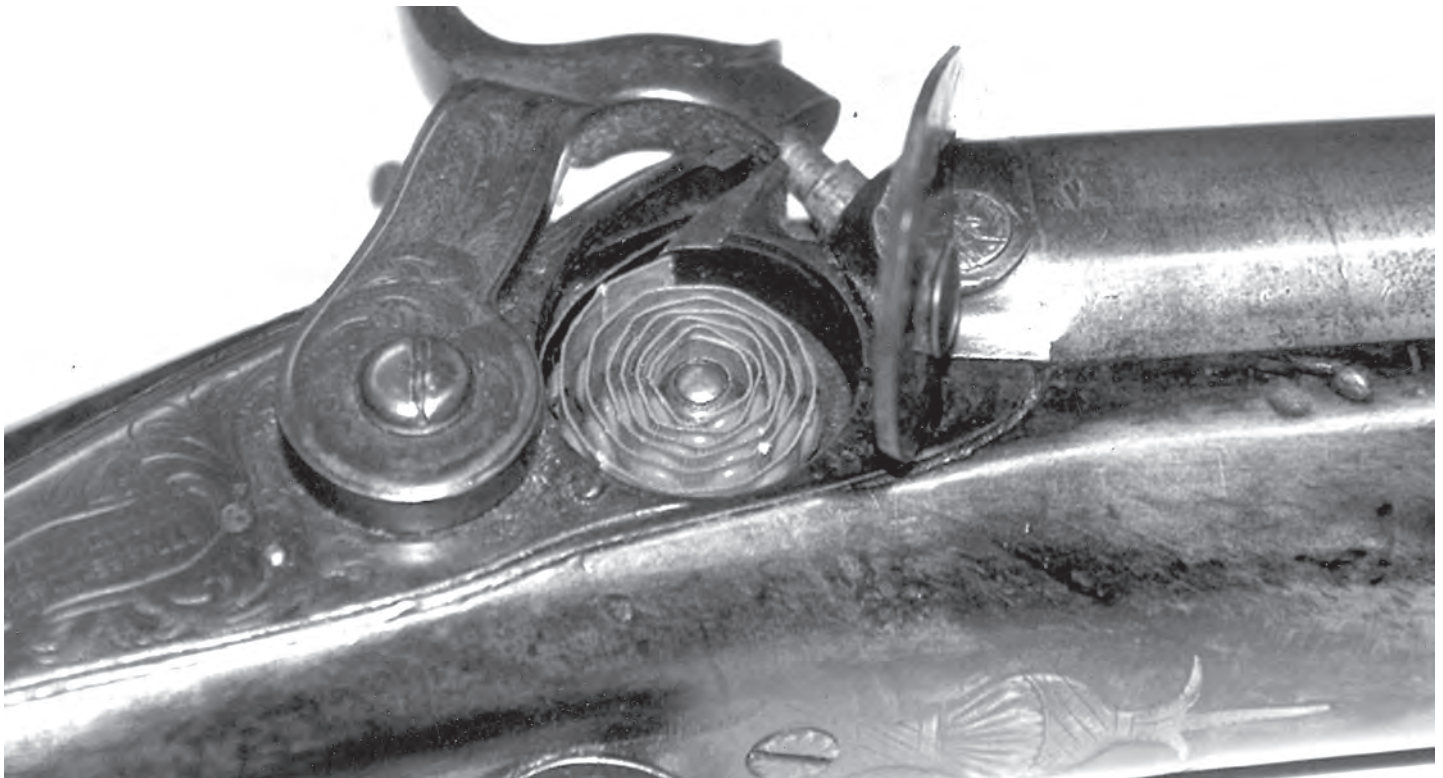

Figure 17. Primer box on Mass. Arms Double Shotgun.

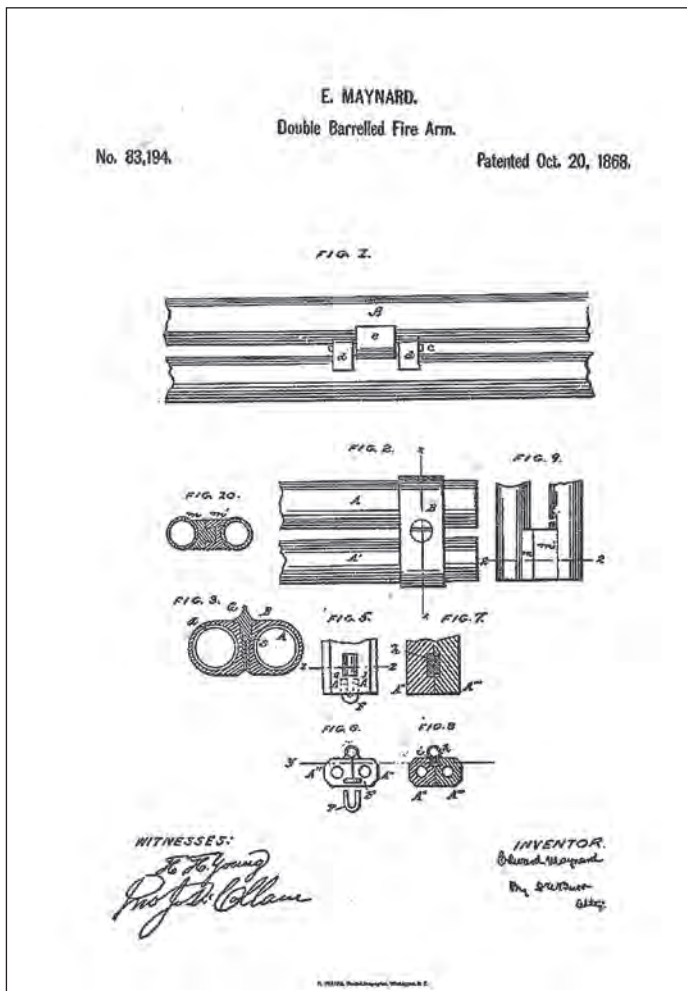

Figure 18. Drawing from Maynard Double Barreled Firearm patent.

This talk has utilized quotes and information from about one fourth of the forty letters from McFarland to Maynard which I have available. I am sure that able researchers will find much more in them than I have presented, and toward that end, I hope to be able to publish these letters as a research resource.

William Putnam McFarland died on June 11, 1903 and is buried in a cemetery in Leicester, Massachusetts. Dr. Maynard died in 1891 and is buried in the old Congressional Cemetery in Washington, DC. At the time of his death, one of his contemporaries, Mr. H. W. Cleveland, wrote:

“The announcement of the death at Washington, D. C., of Dr. Edward Maynard, at the ripe age of more than 77 years, affords a striking illustration of how speedily a man whose name was widely known and honored in his day of active service may drop out of sight and be almost forgotten” . . .

Except among those of us who are collectors, I am afraid that it is true that Maynard is “almost forgotten”.

ACKNOWLEDGMENTS

I would like to thank Robert Holter, Roy Marcot, and Ed Hull for providing resource documents; Dennis Stranger, my friend and brother-in-law, for providing the price index chart and helping to edit and organize this presentation. Thanks to Ron Peterson, who is a never ending source of information about the guns; to my brother, Aurel, who went on wild goose chases, caused by me, taking pictures of alleged

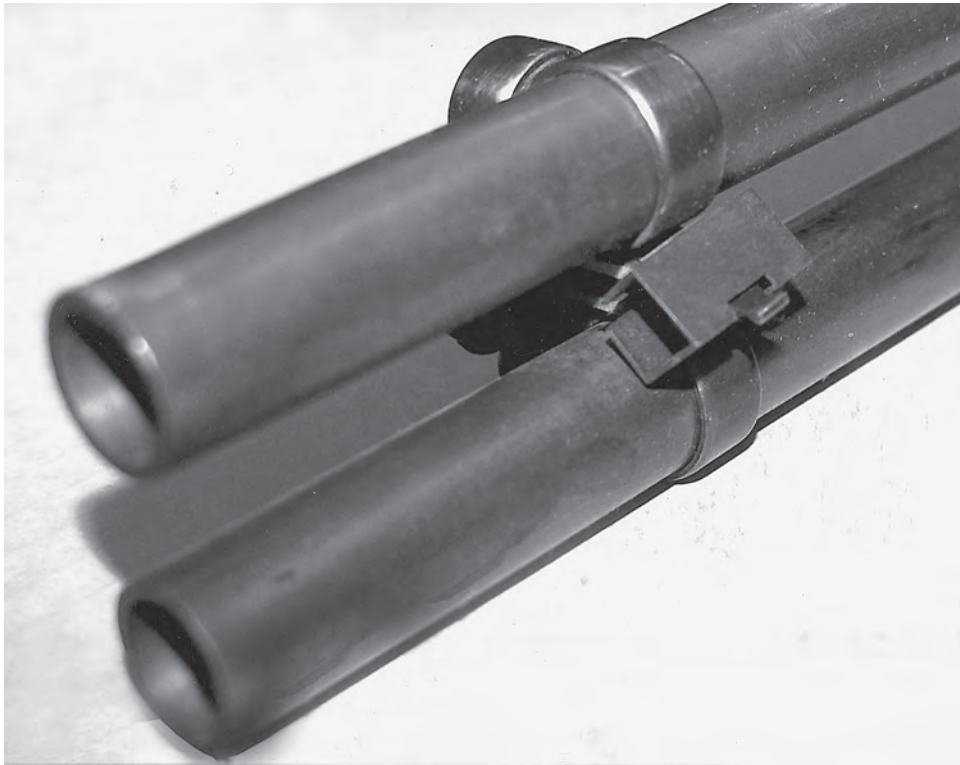

Figure 19. Maynard double gun patent applied to his gun from the muzzle end.

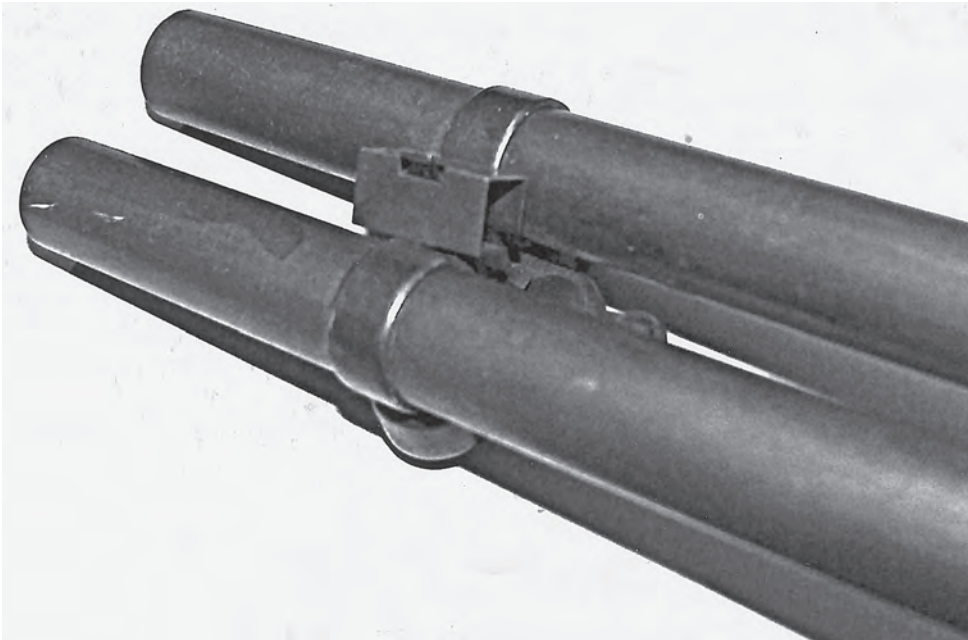

Figure 20. Maynard double gun patent applied to his gun from the breech end.

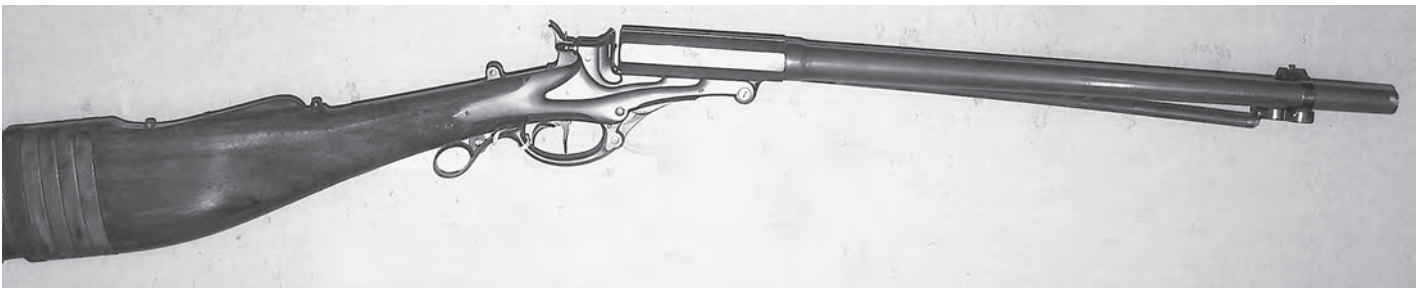

Figure 21. Maynard's double rifle.



Figure 22. The action of Maynard's double rifle.



Figure 23. Maynard Headstone (Photo by Aurel Goodwin).

“Maynard Mansions; to ASAC member Phil Schrier for help in getting into the National Museum of American History; to Harry Hunter, firearms curator of the National Museum of American History for his help in photographing Maynard’s personal guns and in making copies of meeting minutes and other documents. Thanks to Doug Wicklund, curator of the National Firearms Museum for arranging to remove the Massachusetts Arms double barrel shotgun from its display so that I could photograph it. I offer an apology to the people, who over the years, have provided letters and documents, but whose names have been lost. Finally, thanks to my wife and friend, Jeanne for her help, support and suggestions.”

NOTES

1. Ben A. Williamowsky, *Edward Maynard, Prince of Dentists*, Baltimore University, 1946.
2. This is clearly related to his firearms work, rather than dentistry.
3. T. W. Carter was President or Superintendent of Massachusetts Arms Company.
4. Mr. Bestor was elected Secretary of Maynard Arms Company in 1860.

BIBLIOGRAPHY

Edward Maynard, Prince of Dentists, by Ben A. Williamowsky. A paper prepared in partial fulfillment of the requirements of the course in written and oral communications, Baltimore University, 1946.

Springfield Daily Republican, June 12, 1093, page 4.

Consumer Price Index Conversion Chart, prepared by Robert C. Sahr, Political Science Department, Oregon State University, Corvallis, OR.